

UC-8481 Series Hardware Manual

First Edition, May, 2012

www.moxa.com/product



© 2012 Moxa Inc. All rights reserved.
Reproduction without permission is prohibited.

UC-8481 Series Hardware Manual

The software described in this manual is furnished under a license agreement and may be used only in accordance with the terms of that agreement.

Copyright Notice

Copyright ©2012 Moxa Inc.
All rights reserved.
Reproduction without permission is prohibited.

Trademarks

The MOXA logo is a registered trademark of Moxa Inc.
All other trademarks or registered marks in this manual belong to their respective manufacturers.

Disclaimer

Information in this document is subject to change without notice and does not represent a commitment on the part of Moxa.

Moxa provides this document as is, without warranty of any kind, either expressed or implied, including, but not limited to, its particular purpose. Moxa reserves the right to make improvements and/or changes to this manual, or to the products and/or the programs described in this manual, at any time.

Information provided in this manual is intended to be accurate and reliable. However, Moxa assumes no responsibility for its use, or for any infringements on the rights of third parties that may result from its use.

This product might include unintentional technical or typographical errors. Changes are periodically made to the information herein to correct such errors, and these changes are incorporated into new editions of the publication.

Technical Support Contact Information

www.moxa.com/support

Moxa Americas

Toll-free: 1-888-669-2872
Tel: +1-714-528-6777
Fax: +1-714-528-6778

Moxa Europe

Tel: +49-89-3 70 03 99-0
Fax: +49-89-3 70 03 99-99

Moxa China (Shanghai office)

Toll-free: 800-820-5036
Tel: +86-21-5258-9955
Fax: +86-10-6872-3958

Moxa Asia-Pacific

Tel: +886-2-8919-1230
Fax: +886-2-8919-1231

Table of Contents

1. Introduction	1-1
Overview	1-2
Package Checklist	1-2
Product Features	1-2
Product Hardware Specifications	1-Error! Bookmark not defined.
2. Appearance and Dimensions	2-1
Appearance	2-2
Dimensions	2-3
Hardware Block Diagram	2-4
LED Indicators	2-4
Reset Button	2-5
Real Time Clock	2-5
3. Mounting Options	3-1
Wall or Cabinet Mounting	3-2
DIN Rail Assembly	3-2
4. Hardware Connection Description	4-1
Wiring Requirements	4-2
Connecting the Power	4-2
Connecting to the Network	4-3
Connecting to the Serial Device	4-3
Connecting to the Console Port	4-4
CompactFlash	4-5
SIM Card	4-6
USB	4-6
Digital Inputs/Outputs	4-7
Digital Input Wiring	4-7
Digital Output Wiring	4-7
Installing the Wireless Modules	4-8
Installing the Wi-Fi Module	4-9
Installing the Cellular Module	4-11
A. Regulatory Approval Statements	A-1

Introduction

Thank you for purchasing the Moxa UC-8481 RISC-based ready-to-run embedded computer.

The computer uses the Intel XScale IXP435 533MHz RISC CPU. This powerful computing engine is optimized for embedded communication functions and does not generate too much heat. The built-in 32 MB NOR Flash ROM and 512 MB SDRAM give you enough memory to directly run application software, and the 512 MB NAND Flash can be used to provide additional data storage.

Most importantly, the UC-8481 Series comes with mini PCIe connectors and seven antenna port-mounts, to allow users to connect multiple wireless, cellular and GPS modules. This is particularly useful and well-suited for rolling stock applications used on moving vehicles, and makes it easy to construct an intelligent, cost-effective wireless communication platform.

This manual introduces the hardware of the UC-8481 embedded computers. After a brief introduction of the hardware features, we will focus on installing and configuring the hardware.

The following topics are covered in this chapter:

- **Overview**
- **Package Checklist**
- **Product Features**

Overview

The UC-8481 uses the Intel XScale IXP435 CPU. This powerful computing engine is built around a RISC architecture, and clocks in at 533 MHz. The IXP435 runs cool, and is optimized for communication applications. The built-in 32 MB NOR Flash ROM and 512 MB SDRAM give you enough memory to directly run software applications, and a 512 MB NAND Flash is provided for data storage.

Package Checklist

All models of the UC-8481 Series are shipped with the following items:

- 1 UC-8481 embedded computer
- Wall mounting assembly
- DIN rail mounting assembly
- Quick Installation Guide
- Document & Software CD
- CBL-4PINDB9F-100: 100 cm 4-pin-to-DB9 (female-to-female) console port cable, for on-board 4-pin male RS-232 header connector
- Product Warranty Statement

NOTE: Please notify your sales representative if any of the above items are missing or damaged.

Product Features

- Intel XScale IXP435 processor, 533 MHz
- 512 MB DDR2 SDRAM
- 512 MB NAND Flash for data storage
- 32 MB NOR Flash to store OS
- Fanless and rugged design for rolling stock applications requiring EN 50155 compliance
- Multiple wireless module capability for cross-operator applications
- Wireless and GPS modules for multiple communications
- Power cutoff of USB interface for individual cellular module
- Ready-to-run Embedded Linux
- -25 to 70°C wide temperature models available

Product Hardware Specifications

Computer

CPU: Intel XScale IXP435, 533 MHz

OS (pre-installed): Linux

DRAM: 512 MB DDR2 SDRAM onboard

Flash:

32 MB NOR Flash onboard (read-only root file system)

512 MB NAND Flash, expandable up to 1 GB (read-write directories: caching, storage, logging, and configuration)

USB: USB 2.0 hosts x 2

Storage

Storage Expansion: CompactFlash socket

Ethernet Interface

LAN: 2 auto-sensing 10/100 Mbps ports (M12)

Magnetic Isolation Protection: 1.5 KV built in

GPS Module (U-Blox LEA-6S)

Receiver Types:

- 50-channel U-blox 6 engine
- GPS L1 C/A code
- GALILEO L1 open service (with upgrade)
- SBAS:WAAS, EGNOS, MSAS, GAGAN

Acquisition:

- Cold starts: 28s
- Warm starts: 28s
- Aided starts: 1s
- Hot starts: 1s

Sensitivity:

- Tracking: -160 dBm
- Reacquisition: -160 dBm
- Cold starts: -147 dBm

Timing accuracy:

- RMS: 30 ns
- 99%: <60 ns
- Granularity: 21 ns

Accuracy:

- Position: 2.5m CEP
- SBAS: 2.0m CEP

Protocols: NMEA, UBX binary, max. update rate: 5Hz (ROM version)

Time Pulse: 0.25Hz to 1KHz

Velocity Accuracy: 0.1 m/s

Heading Accuracy: 0.5 degrees

A-GPS: Supports AssistNow Online and AssistNow Offline, OMA SUPL compliant

Operational Limits: Velocity:500m/s(972 knots)

Connector Type: TNC

WLAN Module (Atheros AR9220)

WAPN001: IEEE802.11a/b/g/n wireless LAN module with U.FL antenna connector

Standards: IEEE802.11a/b/g/n for wireless LAN

Connector Type: QMA connector (female type) x 2

Mode: Client

Cellular Module (Cinterion PH8)

Frequency Bands: GSM/GPRS/EDGE/UMTS/HSPA+

Band Options:

- Five band UMTS(WCDMA/FDD)

- 800/850/1900 AWS and 2100 MHz
- Quad-band GSM: 850/900/1800/1900 MHz

HSDPA/HSUPA Data Rates:

DL: 3.6/7.2/14.4 Mbps

UL: 2.0/5.76 Mbps

UMTS Data Rates:

DL: max 384 Kbps

UL: max 384 Kbps

EDGE Class 12:

DL: max 237 Kbps

UL: max 237 Kbps

GPRS Class 12:

DL: max 85.6 Kbps

UL: max 85.6 Kbps

Connector Type: QMA connector (female type) x 1

Serial Interface

Serial Standards: 2 RS-232/422/485 ports, software-selectable (DB9)

Console Port: RS-232 (TxD, RxD, GND), 4-pin pin header output (115200, n, 8, 1)

Serial Communication Parameters

Data Bits: 5, 6, 7, 8

Stop Bits: 1, 1.5, 2

Parity: None, Even, Odd, Space, Mark

Flow Control: RTS/CTS, XON/XOFF, ADDC® (automatic data direction control) for RS-485

Baudrate: 50 bps to 921.6 Kbps (supports non-standard baudrates; see user's manual for details)

Serial Signals

RS-232: TxD, RxD, DTR, DSR, RTS, CTS, DCD, GND

RS-422: TxD+, TxD-, RxD+, RxD-, GND

RS-485-4w: TxD+, TxD-, RxD+, RxD-, GND

RS-485-2w: Data+, Data-, GND

Digital Input

Input Channels: 4, source type

Input Voltage: 0 to 30 VDC

Digital Input Levels for Dry Contacts:

- Logic level 0: Close to GND
- Logic level 1: Open

Digital Input Levels for Wet Contacts:

- Logic level 0: +3 V max.
- Logic level 1: +10 V to +30 V (COM to DI)

Connector Type: 10-pin screw terminal block (4 points, COM, GND)

Isolation: 2 KV optical isolation

Digital Output

Output Channels: 4, sink type

Output Current: Max. 200 mA per channel

On-state Voltage: 24 VDC nominal, open collector to 30 V

Connector Type: 10-pin screw terminal block (4 points, GND)

LEDs

System: Power, Ready, Storage, Programmable

LAN: 10M/Link x 2, 100M/Link x 2 (on connector)

Serial: TxD x 2, RxD x 2

Reset Button: Supports "Reset to Factory Default"

Physical Characteristics

Housing: SECC sheet metal (1 mm)

Weight: 1 kg

Dimensions: 200 x 57 x 120 mm (7.87 x 2.24 x 4.72 in)

Mounting: DIN rail, wall

Environmental Limits

Operating Temperature:

Standard Models: -25 to 55°C (-13 to 131°F)

Wide Temp. Models: -25 to 70°C (-13 to 158°F)

Storage Temperature:

Standard Models: -25 to 75°C (-13 to 167°F)

Wide Temp. Models: -40 to 80°C (-40 to 176°F)

Ambient Relative Humidity: 5 to 95% (non-condensing)

Anti-vibration: IEC 61373 standard

Anti-shock: IEC 61373 standard

Power Requirements

Input Voltage: 24 VDC (9 to 48 V), M12 connector

Power Consumption: 20 W

- 833 mA @ 24 VDC

Standards and Certifications

Safety: UL 60950-1, EN 60950-1

EMC: EN 55022 Class B, EN 55024-4-2, EN 55024-4-3, EN 55024-4-4, FCC Part 15 Subpart B Class B

Rail Traffic: EN 50155, EN 50121-2-3, EN 50121-4, IEC 61373

Reliability

Alert Tools: Built-in buzzer and RTC (real-time clock)

Automatic Reboot Trigger: Built-in WDT (watchdog timer)

Warranty

Warranty Period: 5 years (does not apply to cellular module)

Details: See www.moxa.com/warranty

Note: The Hardware Specifications apply to the embedded computer unit itself, but not to accessories. In particular, the wide temperature specification does not apply to accessories such as the power adaptor and cables.

Appearance and Dimensions

The following topics are covered in this chapter:

- **Appearance**
- **Dimensions**
- **Hardware Block Diagram**
- **LED Indicators**
- **Reset Button**
- **Real Time Clock**

Appearance

Front View

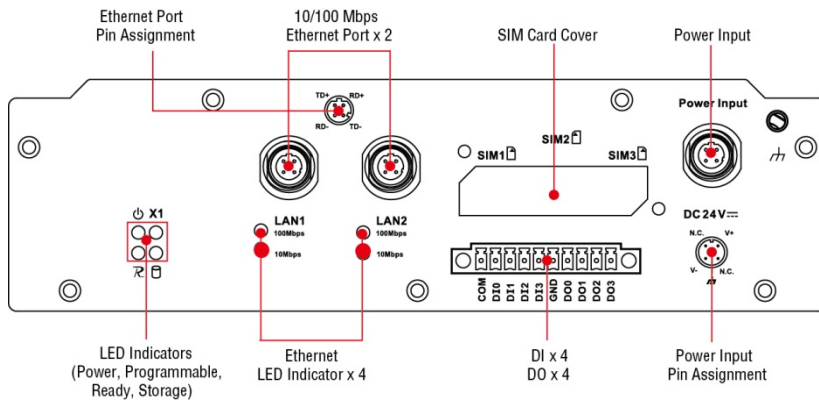

Top View

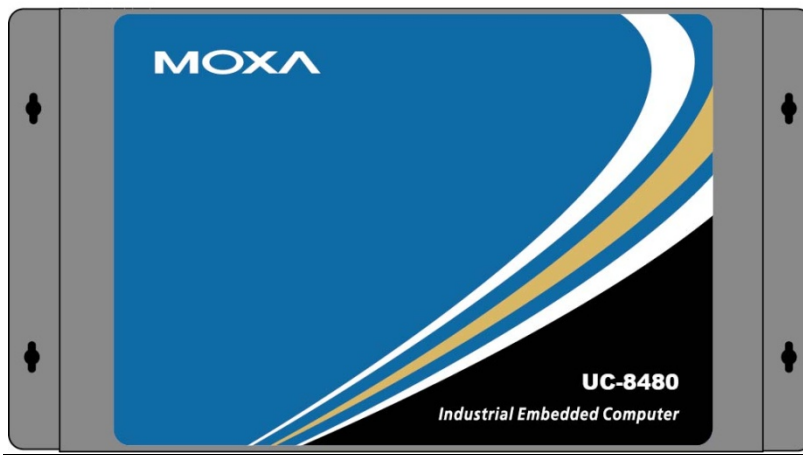

Rear View

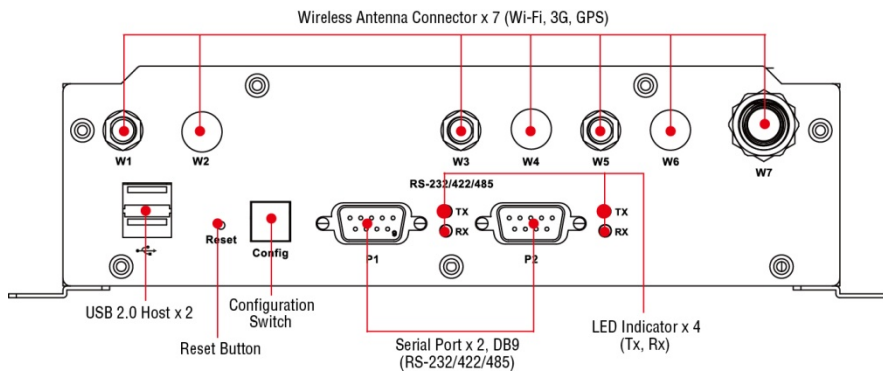

Dimensions

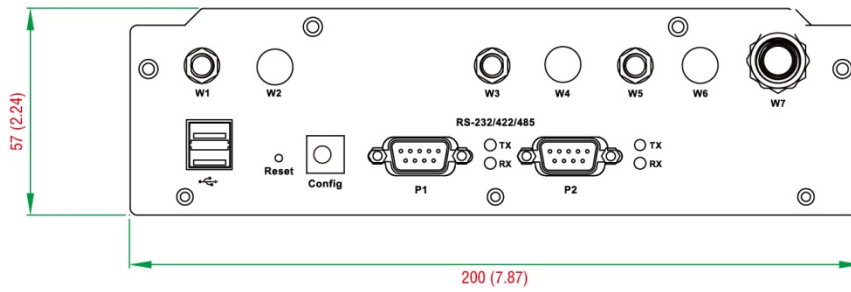
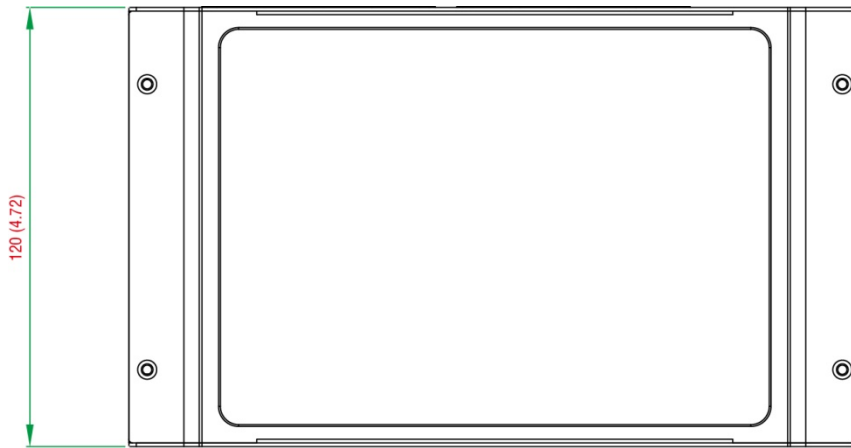

(Unit=mm)

Hardware Block Diagram

The following block diagram shows the layout of the UC-8481’s internal components.

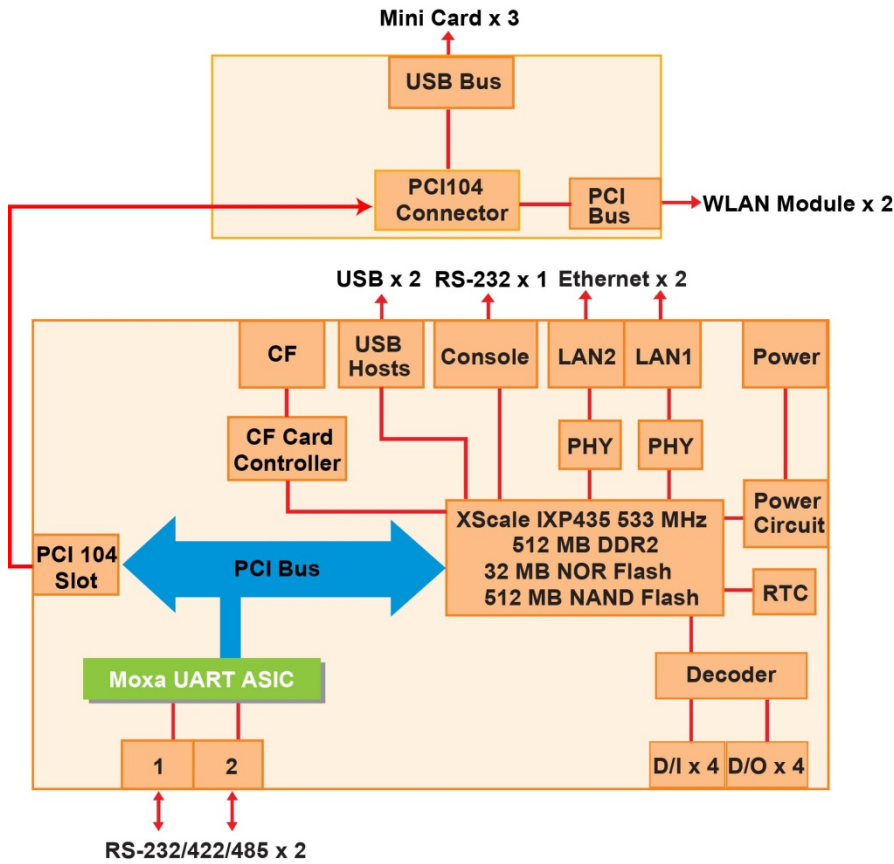

LED Indicators

The UC-8481 has 14 LED indicators on the top panel. Refer to the following table for information about each LED.

LED Name	LED Color	LED Function
Power	Green	Power is on and functioning normally
	Off	Power is off, or there is a power malfunction
Storage	Yellow	CF card has been detected
	Off	CF card has not been detected
Ready	Green	The system is ready
	Off	The system is not ready
X1 (programmable)	Green	[This LED must be defined by the user, as a "programmable function"]
	Off	[This LED must be defined by the user, as a "programmable function"]
LAN (1, 2)	Green	100 Mbps Ethernet mode
	Yellow	10 Mbps Ethernet mode
	Off	No LAN activity
Tx, Tx (P1-P2)	Green	Serial ports P1-P2 transmitting data
	Off	Serial ports P1-P2 not transmitting data
Rx, Rx (P1-P2)	Yellow	Serial ports P1-P2 receiving data
	Off	Serial ports P1-P2 not receiving data

Reset Button

The button labeled **Reset** returns the UC-8481 to its factory-default configuration.

Press the **Reset** button continuously for at least 5 seconds to load the **factory-default configuration**. After the factory defaults have been loaded, the system will reboot automatically. The **Ready** LED will blink on and off for the first 5 seconds, and then maintain a steady glow once the system has rebooted.

We recommend that you only use this function under extreme circumstances, where the software is not working properly and you must reload the device's default settings. To reset an embedded system, it is always preferable to use the software reboot command (`/>reboot`) where possible, to protect data integrity.



ATTENTION

The Reset button preserves permanent user data

The **Reset** button will NOT format the user directory, nor erase user data. Pressing the reset button continuously for at least 5 seconds will only reload configuration files. For the Linux OS, all files in the **/etc**, **/home** and **/tmp** directories will revert to their factory configuration, but user data in the Flash ROM will be unaffected. For the Windows CE 6.0 OS, all configuration and registry files will revert to their factory defaults.

Real Time Clock

The UC-8481's real time clock is powered by a lithium battery. We strongly recommend that you do not replace the lithium battery without help from a qualified Moxa support engineer. If you need to change the battery, contact the Moxa RMA service team.



WARNING

There is a risk of explosion if the battery is replaced by an incorrect type.

3

Mounting Options

The following topics are covered in this chapter:

- ❑ **Wall or Cabinet Mounting**
- ❑ **DIN Rail Assembly**

Wall or Cabinet Mounting

The two metal brackets that come standard with the UC-8481 are used to attach the UC-8481 to a wall or the inside of a cabinet. First, use two screws per bracket to attach the brackets to the bottom of the UC-8481 (Fig. A). Next, use two screws per bracket to attach the UC-8481 to a wall or cabinet (Fig. B).

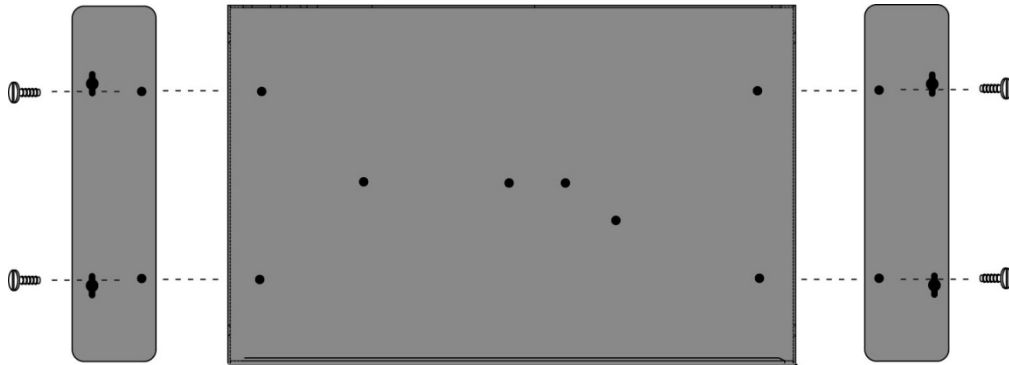

Figure A: UC-8481 Embedded Computer—Wall Mounting Assembly (bottom view)

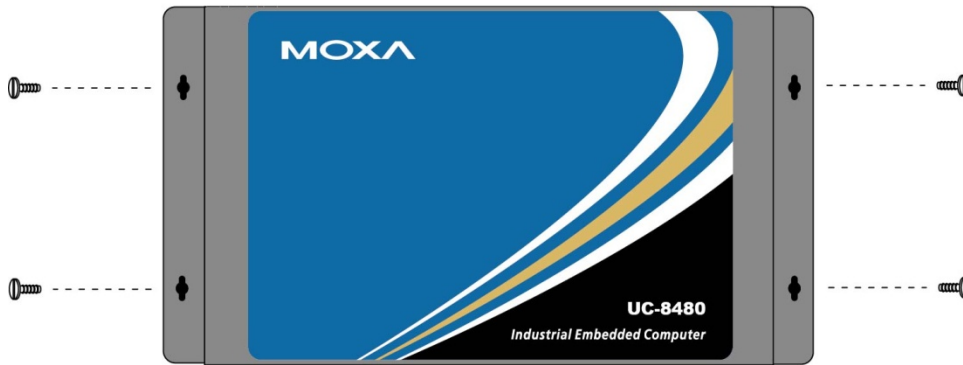

Figure B: UC-8481 Embedded Computer—Wall Mounting Assembly (top view)

DIN Rail Assembly

An aluminum DIN rail attachment plate is included with the product. When attaching the rail mount to the UC-8481, make sure the metal spring is situated towards the top, as shown in the following figures.

<p>STEP 1: Insert the top of the DIN rail into the slot just below the stiff metal spring.</p>	<p>STEP 2: The DIN rail attachment unit will snap into place as shown below.</p>

To remove the UC-8481 from the DIN rail, simply reverse Steps 1 and 2.

Hardware Connection Description

This section describes how to connect the UC-8481 to serial devices for initial testing purposes.

The following topics are covered in this chapter:

- **Wiring Requirements**
- **Connecting the Power**
- **Connecting to the Network**
- **Connecting to the Serial Device**
- **Connecting to the Console Port**
- **CompactFlash**
- **SIM Card**
- **USB**
- **Digital Inputs/Outputs**
- **Connecting to the Wireless Modules**

Wiring Requirements



ATTENTION

Safety First!

Be sure to disconnect the power cord before installing and/or wiring your UC-8481.

Wiring Caution!

Calculate the maximum possible current in each power wire and common wire. Observe all electrical codes dictating the maximum current allowable for each wire size.

If the current goes above the maximum ratings, the wiring could overheat, causing serious damage to your equipment.

Temperature Caution!

Be careful when handling the UC-8481. When plugged in, the UC-8481's internal components generate heat, and the outer casing may feel hot to the touch.

You should also observe the following common wiring rules:

- Use separate paths to route wiring for power and devices. If power wiring and device wiring paths must cross, make sure the wires are perpendicular at the intersection point.
NOTE: Do not run signal or communication wiring and power wiring in the same wire conduit. To avoid interference, wires with different signal characteristics should be routed separately.
- You can use the type of signal transmitted through a wire to determine which wires should be kept separate. The rule of thumb is that wiring that shares similar electrical characteristics can be bundled together.
- Keep input wiring and output wiring separate.
- Where necessary, we strongly recommend that you label all system wiring, for all devices in the system.

Connecting the Power

The UC-8481 has a 5-pin M12 connector that serves a 24 VDC power input.

The following figures show how the power input connects to external power source. If the power is properly supplied, the **Ready** LED will illuminate with a solid green color after 30 to 60 seconds have passed.

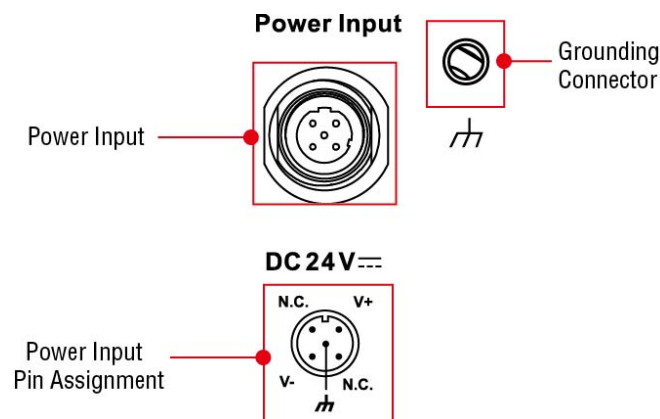

ATTENTION

The power for this product should be supplied by a listed power supply unit rated to deliver 12 to 48 VDC at a minimum of 1280 mA for 12 VDC, and 300 mA for 48 VDC.

Grounding the UC-8481

Grounding and wire routing help limit the effects of noise from electromagnetic interference (EMI). Run the ground connection from the ground screw to the grounding surface prior to connecting devices.



ATTENTION

This product is intended to be mounted to a well-grounded mounting surface, such as a metal panel.

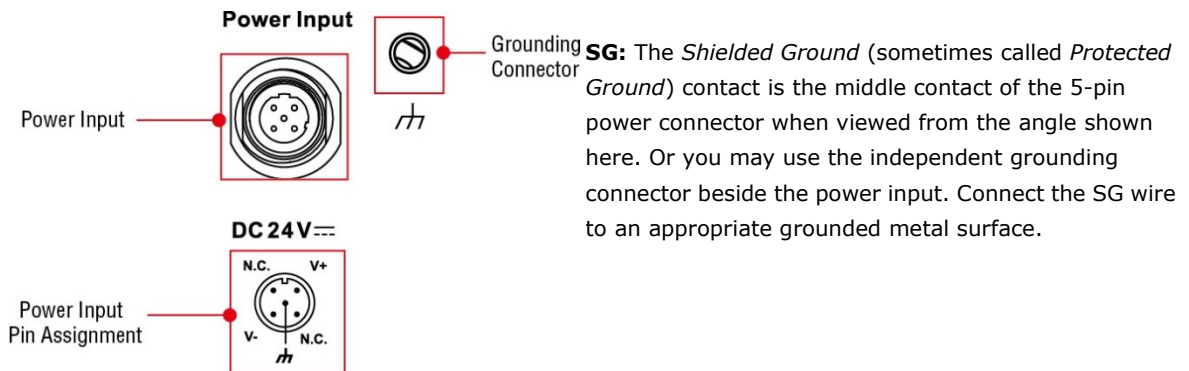

Connecting to the Network

Connect one end of the Ethernet cable to one of the UC-8481's 10/100M Ethernet ports (M12) and the other end of the cable to the Ethernet network. See the following figure for the M12 Ethernet connector pin assignments:

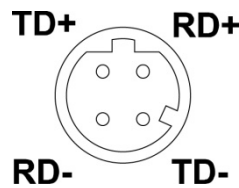

Connecting to the Serial Device

Use properly wired serial cables to connect the UC-8481 to serial devices. The UC-8481's serial ports (P1 to P2) use 9-pin male DB9 connectors. The ports can be configured by software for RS-232, RS-422, or 2-wire RS-485. The precise pin assignments are shown in the following table:

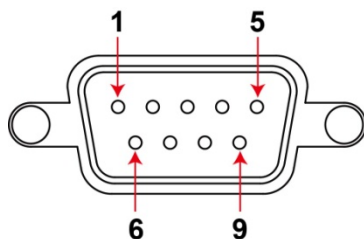

Pin	RS-232	RS-422/ RS-485-4w	RS-485-2w
1	DCD	TxD-(A)	-
2	RxD	TxD+(B)	-
3	TxD	RxD+(B)	Data+(B)
4	DTR	RxD-(A)	Data-(A)
5	GND	GND	GND
6	DSR	-	-
7	RTS	-	-
8	CTS	-	-

Connecting to the Console Port

The UC-8481's console port is an RS-232 4-pin header connector. Refer to the following figure for pin assignments on the console port cable.

Serial Console Port and Pinouts



Pin	Signal
1	TxD
2	RxD
3	NC
4	GND

Serial Console Cable



The console port is located just below the CF card socket, on the opposite side of the motherboard. Use a screwdriver to remove the two screws holding the cover to the embedded computer's housing.

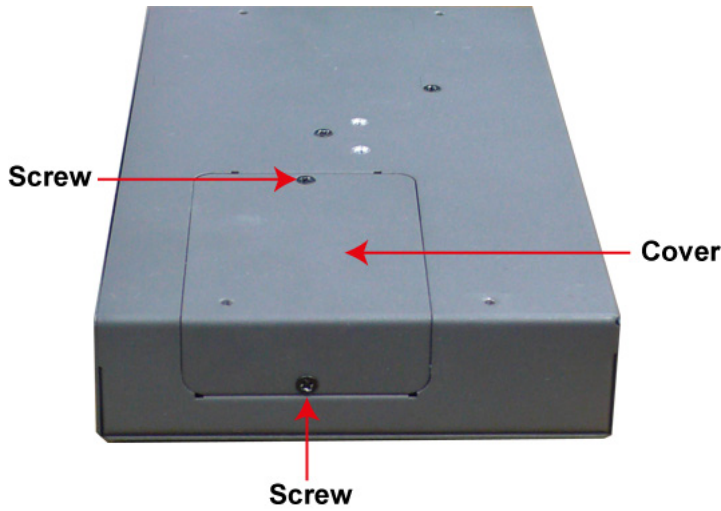

Refer to the following figure to see the precise location of the console port.

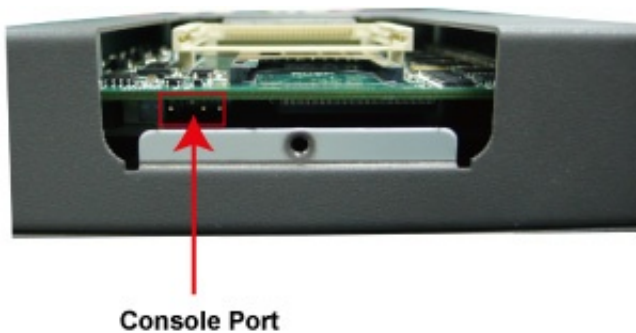

CompactFlash

The UC-8481 provides one CompactFlash (CF) slot that supports CompactFlash type I/II card expansion. Currently, Moxa provides a CF card for storage expansion.



WARNING

Be sure to power off the computer before inserting or removing the CompactFlash card.

The following description explains the installation process for CompactFlash cards.

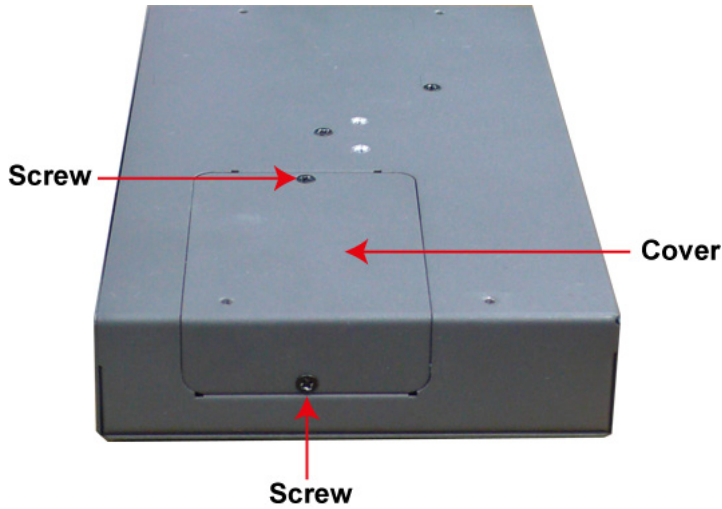

The CF is located on the motherboard beneath the cover at the back of the UC-8481. Use a screwdriver to remove the cover and access the slot. See the following figure for the locations of the CF socket.

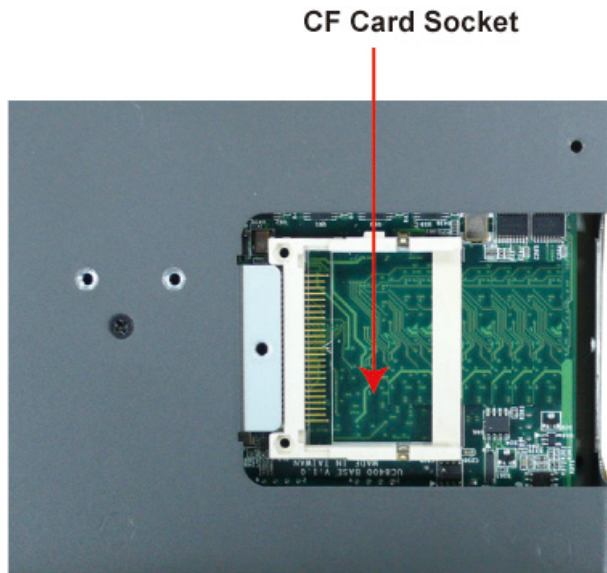

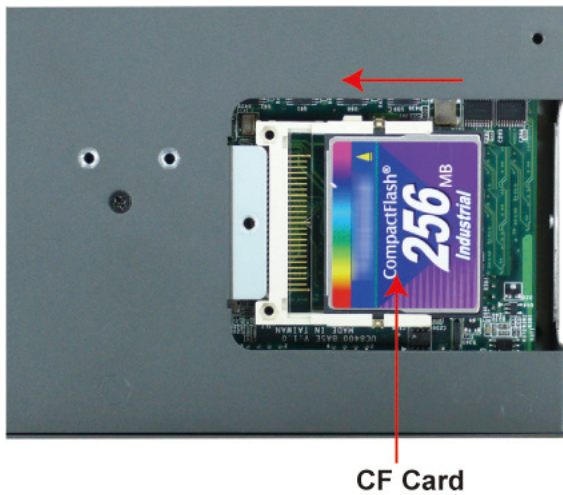

If you need device drivers for other kinds of mass storage cards, contact Moxa for information on how to initiate a cooperative development project.

SIM Card

The UC-8481 comes with 3 SIM card sockets that users can use to install three SIM cards for cellular communications. To insert a SIM card, remove the cover at the front panel and insert the SIM card according to the specific locations. The default cellular module uses the SIM1 socket.

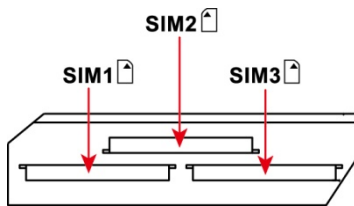

USB

For additional storage expansion, the UC-8481 provides two USB 2.0 ports on the rear panel.

Digital Inputs/Outputs

The UC-8481 has 4 digital outputs and 4 digital inputs. The pinouts for the I/O are shown in the following figures:

Digital Input Wiring

Dry Contact

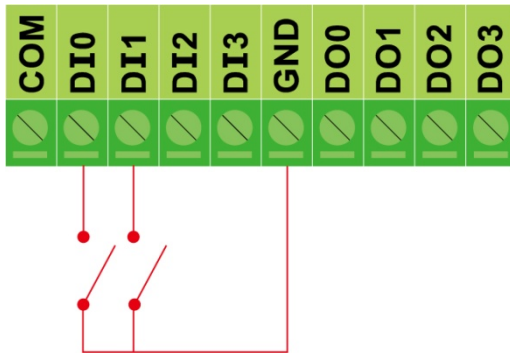

Wet Contact

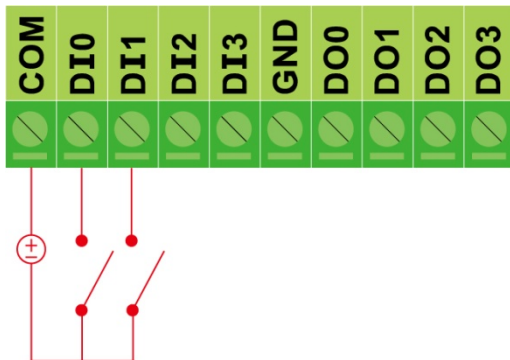

Note: If are using wet contacts, you must connect "COM" to power.

Digital Output Wiring

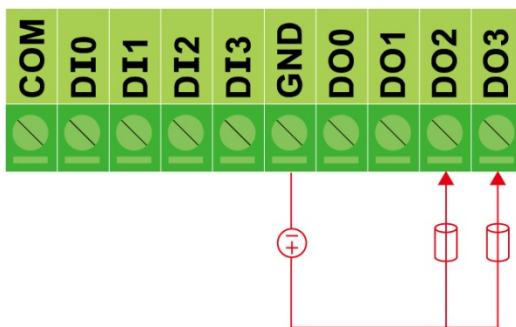

Installing the Wireless Modules

The UC-8481 comes with 1 Wi-Fi module and 1 cellular module pre-installed. However, users may add up to 1 Wi-Fi module and 2 cellular modules for further wireless connectivity.

To connect further wireless modules you first need to remove the four screws on the top panel, two screws on the front panel, and two screws on the rear panel. See the following figures for the details of screw locations.

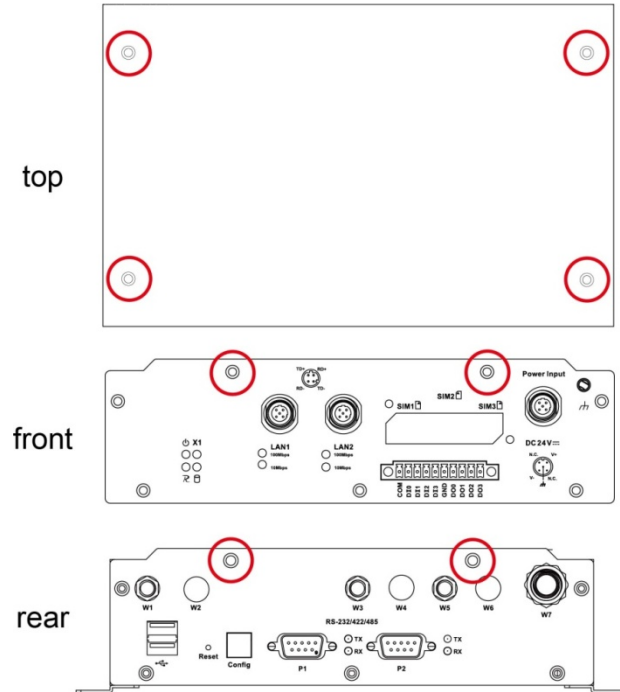

Only after removing all eight screws can you remove the top cover. One Wi-Fi module and one cellular module are pre-installed on the UC-8481's mini PCIe sockets. There are two more slots available for additional modules. Please note that Cellular Socket 2 can only accommodate a Cinterion PH8 cellular module, while either only a Wi-Fi or only a cellular module may occupy the remaining slot ("Socket 2").

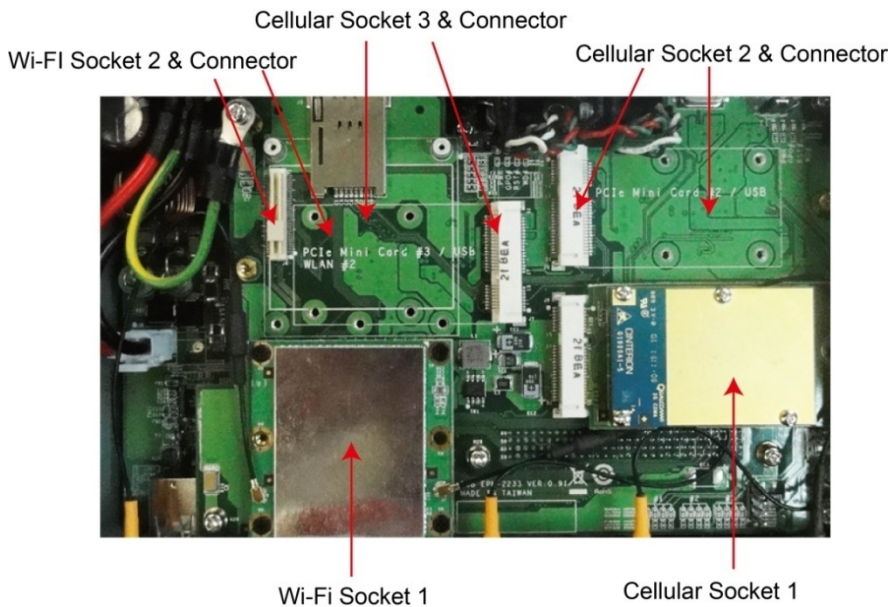

Please note that the cellular sockets are USB interfaces across Mini PCIe connectors; it is also possible to purchase Wi-Fi modules that use the same interface (mini PCIe with USB interface) for installation on the cellular sockets.

Installing the Wi-Fi Module

1. The Wi-Fi Module package includes 1 Wi-Fi module, 2 Wi-Fi antenna cables and connectors, 1 thermal pad, 5 black screws and 3 bronze screws.

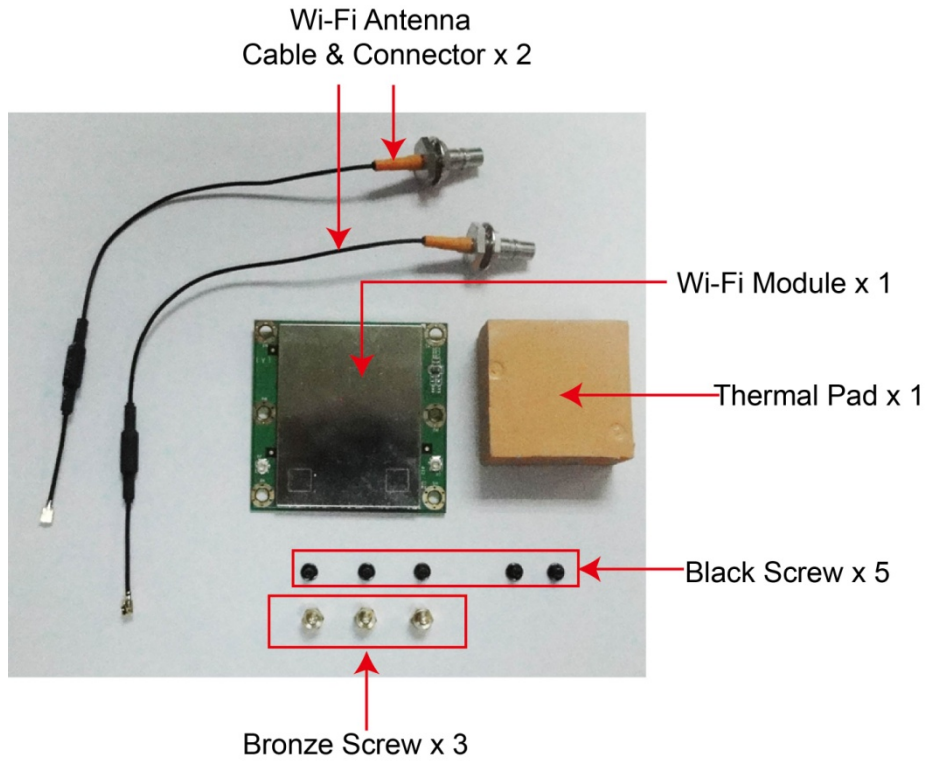

2. To install the module, first find the locations of the antenna connectors and connect the antenna cables to the module. Please note that there are two antenna cables on each side of the module.

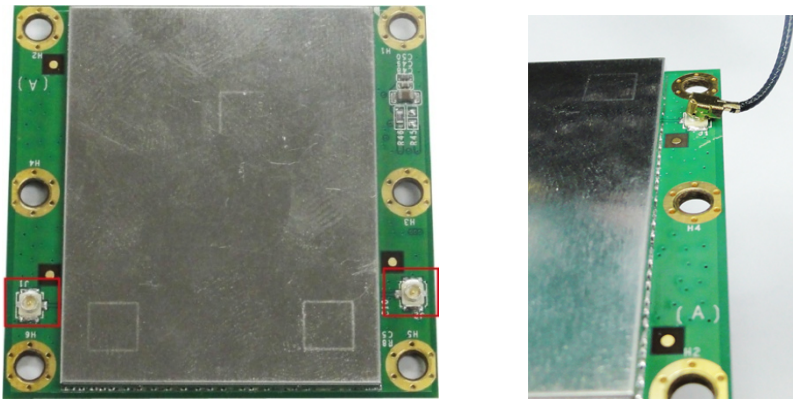

3. Fasten three the bronze standoffs on the socket.

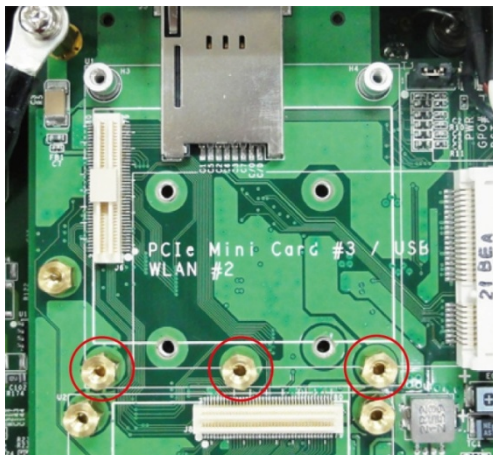

4. Remove the socket protection cover.

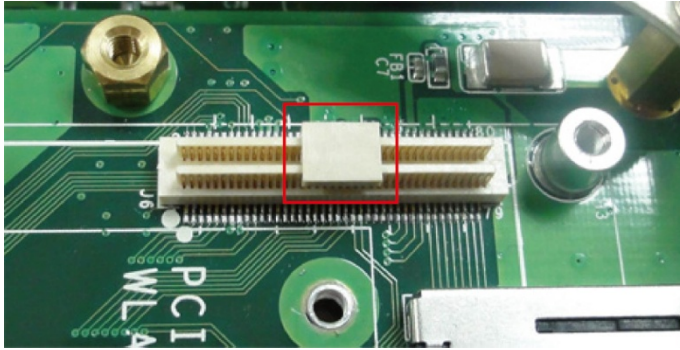

5. Install the module on the socket, and fasten the five black screws on the module. Please note that two of them are threaded differently and need to be fastened on one side of the module (on the aluminum standoffs), and the other three need to be fastened on the other side (on the brass standoffs).

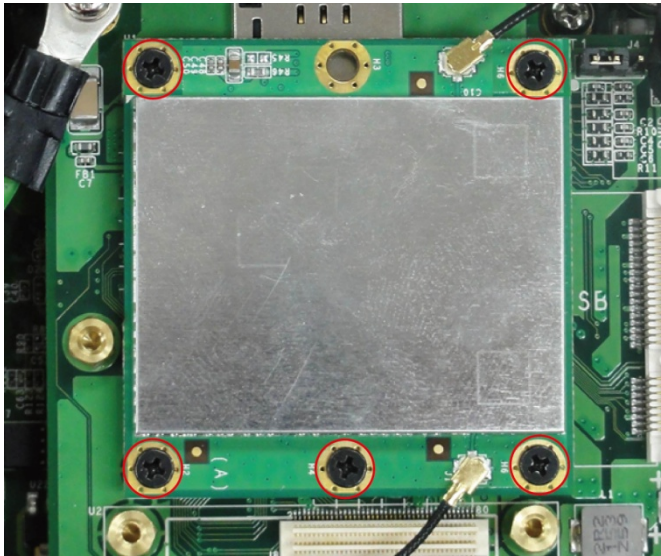

6. Connect the Wi-Fi module antenna connectors by using the W2 and W4 holes on the rear panel of the computer. Remove the antenna hole protection cover first.



7. Remove the nut and locking washer from the threaded antenna connector.



8. Pass the antenna mount's threaded connection ring through the mounting hole; keeping the locking washer against the rear panel face, secure the antenna connector by by tightening the provided nut onto the threaded protection ring.

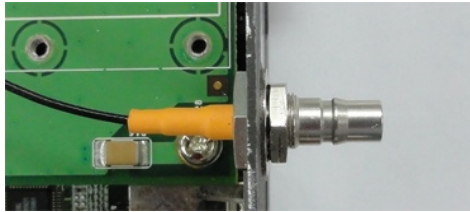

9. When finished, place the thermal pad on the module, check to make sure the internal antenna wire is securely connected to the Wi-Fi module, and resecure the cover on to the computer.

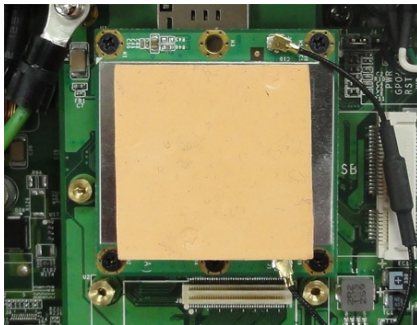

10. The Wi-Fi antenna may now be connected via the connector on the rear panel of the computer.

Installing the Cellular Module

1. Unpack the cellular module package. It should include 1 cellular module, 1 cellular antenna cable and connector, 1 thermal pad, 1 black screw and 1 bronze standoff. Please note that the antenna cable and connector should already be connected to the cellular module.

Cellular Antenna
Cable & Connector x 1

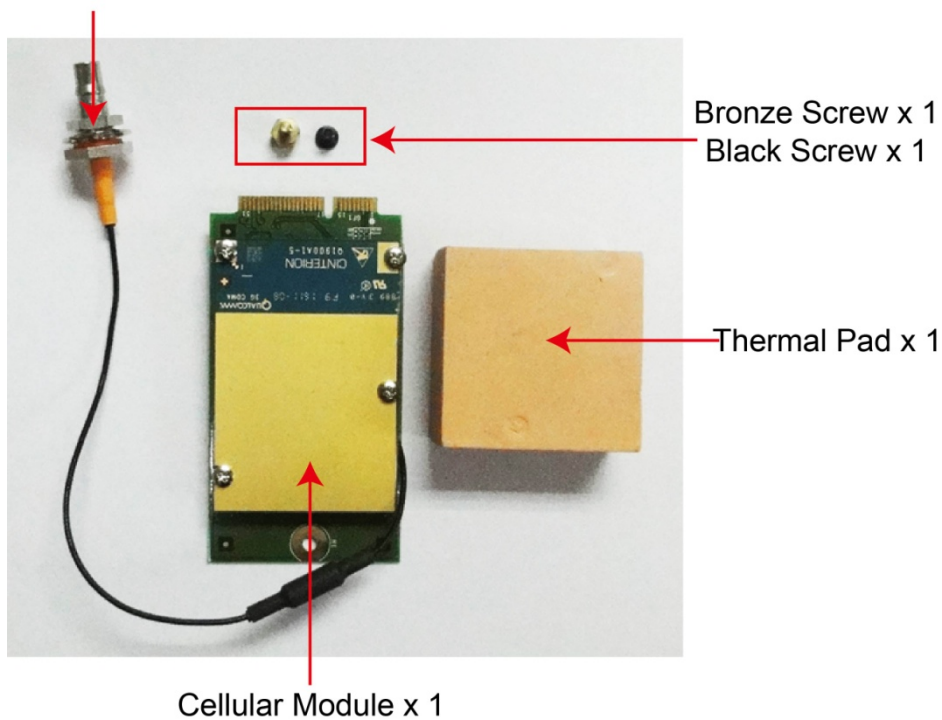

j

2. You may install the cellular module on either Cellular Socket 2 or Cellular Socket 3. Before installing, you need you fasten the bronze standoff to the appropriate socket location. See the following figure for details on where these spots are located on the various sockets.

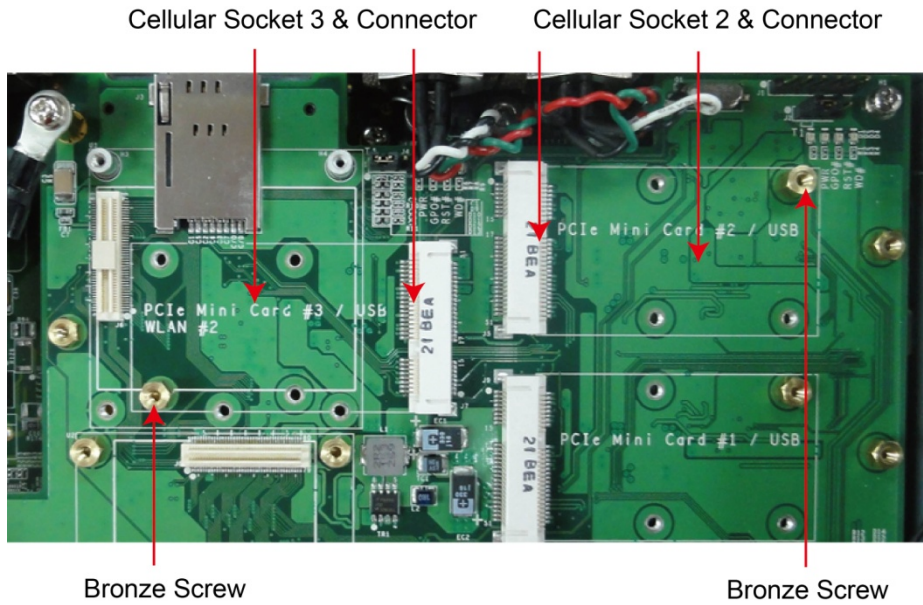

3. Install the cellular module into the socket by fastening the black screw into the standoff, at the end of the module.



4. Connect the cellular module antenna connectors to either the W2 or W4 hole on the rear panel of the computer. First, remove the antenna hole protection cover.



- Remove the nut and locking washer from the threaded antenna connector.

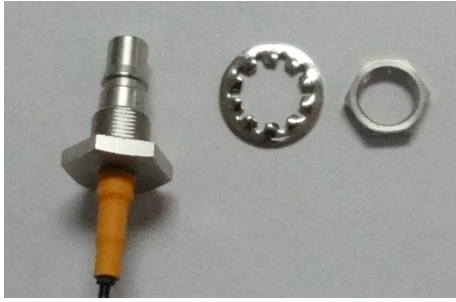

- Pass the antenna mount's threaded connection ring through the mounting hole; keeping the locking washer against the rear panel face, secure the antenna connector by tightening the provided nut onto the threaded protection ring.

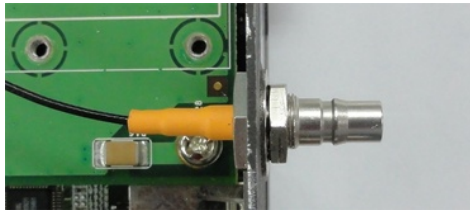

- When finished, place the thermal pad on the module, check to make sure the internal antenna wire is securely connected to the Wi-Fi module, and resecure the cover on to the computer.



- The cellular antenna may now be connected via the connector on the rear panel of the computer.

Connecting the Antenna

The UC-8481 comes with its GPS, 3G GSM/HSPA+, and dual 802.11n antenna connectors already mounted by default; three more empty port-holes are provided, to be used when mounting antenna connectors for additional wireless, cellular or GPS modules. The following chart indicates the default configuration of antenna mounts:

W1	W2	W3	W4	W5	W6	W7
WLANA	N/A	WLANB	N/A	3G	N/A	GPS

Antenna connectors for the default 802.11n module are mounted on the W1 and W3 port-holes; connectors for the cellular GSM/GPRS/EDGE/UMTS/HSPA+ module uses the W5 port, and for the GPS module, on the W7 port. We strongly recommend that only qualified technical engineers for antenna installations, as this is a specific product that requires professional mounting and configuration.

A

Regulatory Approval Statements



This device complies with part 15 of the FCC Rules. Operation is subject to the following two conditions: (1) This device may not cause harmful interference, and (2) this device must accept any interference received, including interference that may cause undesired operation.